

Fundo Click and Seal™

wedi drain technology for tiled showers

The safe, waterproof and factory integrated wedi alternative to conventional and bonding flange drains.

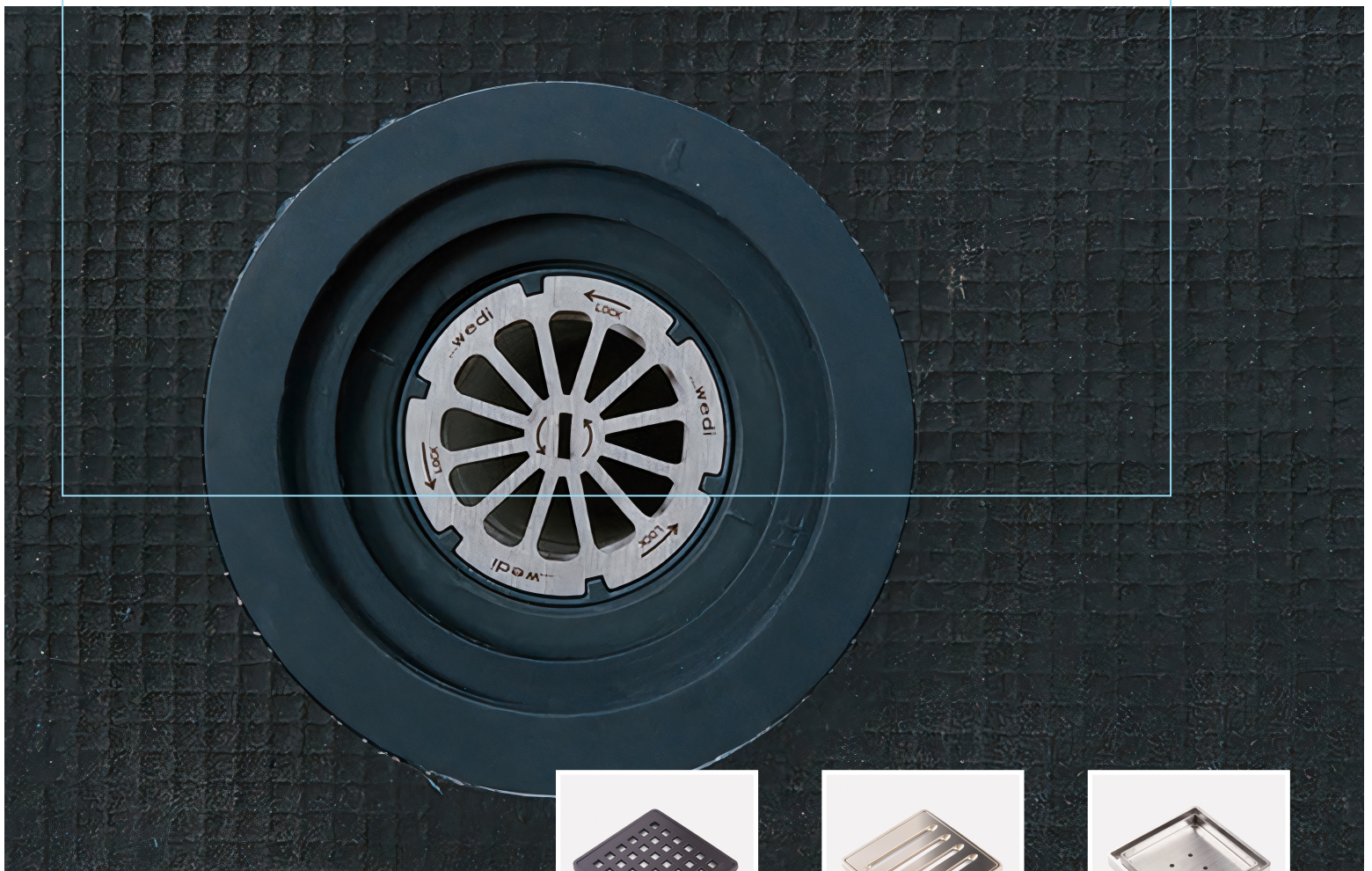
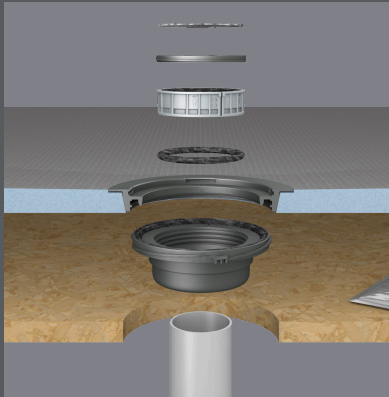

Table of Contents



01 Fundo Click and Seal™

- Drain System Introduction.....3
- Drain Parts Overview.....4
- Benefits of Fundo Click and Seal™5
- How wedi Supports You - First Time Fundo Click and Seal™ Use.....5

02 Premium Drain Covers

- wedi Premium Point Drain Covers7
- wedi Fundo Riolito/Riolito Modular Drain Covers7

03 Installation Tips

- Fundo Click and Seal™ Installation Tips..... 8-11

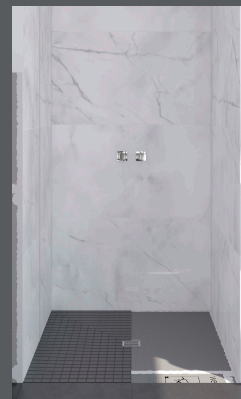

01

Fundo Click and Seal™

Our new Fundo Click and Seal™ wedi drain continues the successful performance of our previously used drain technology by ensuring safe performance over time, and offering added simplicity in assembly. The new wedi “Fundo Click and Seal™” drain allows us to offer one drain and installation process that fits all our Fundo designs.

Our customers can now enjoy all features and functional upgrades with wedi Fundo Click and Seal™ **no matter the design of the shower, whether it is a standard point drain shower, a linear drain shower, or a curbless floor-even shower.** This further simplifies the installation process and makes professional installer/crew training easier than before.

Starting as early as **January 1st, 2023**, the first models and sizes equipped with a Fundo Click and Seal™ drain will start replacing the current versions which will eventually be sold out during 2023.

It will be important to note that during that time **two versions of Fundo systems will be supported.**

The Fundo Click and Seal™ drain unit will be included in the shower base box. Drain Cover units will be sold individually a la carte.

The new Fundo Click and Seal™ equipped shower bases are marked “Includes Fundo Click and Seal™ drain in box- select drain cover sold/package separately” . The shower bases carry new item numbers.

We have also simplified pricing for you. All Fundo Click and Seal™ bases are now available for a consistent retail price per square foot in each of the groups: Primo, Ligno and Riolito. Ask your distributor for applicable discounts off wedi retail pricing.

In addition we have also adjusted our Fundo Kit pricing to ensure a cost advantage of 6% with every Fundo Kit when compared to the cost of products individually purchased.



Drain Parts Overview

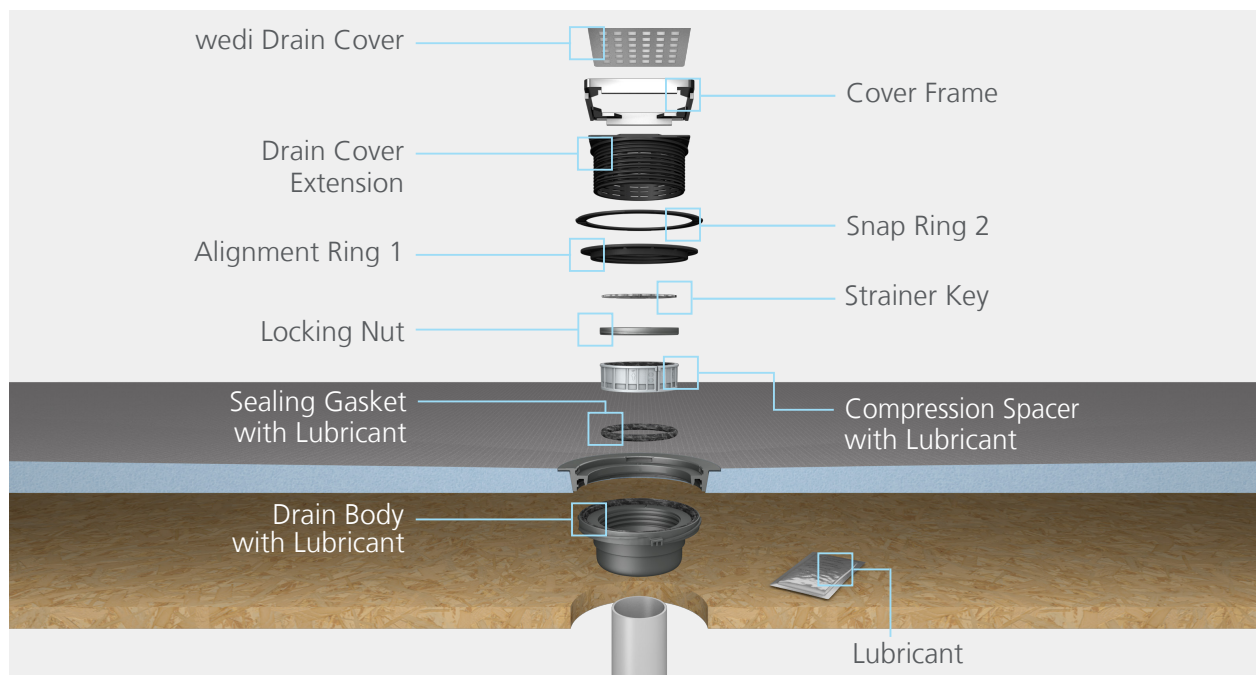

Pressure fit seal with a "click" sound – no plumbing license or glue needed, and seals securely to ABS, PVC, or cast iron waste pipe.

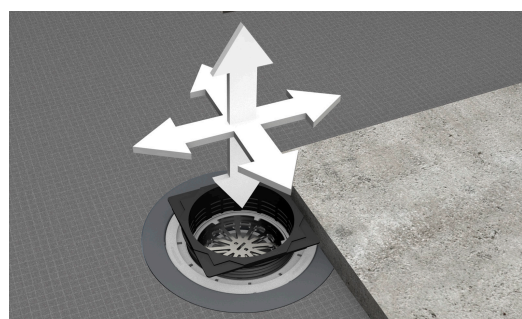

Drain cover can be moved up to 1 ¼ inch high (vertical), and also up to 3/16 of an inch sideways (lateral) to accommodate any size tile.

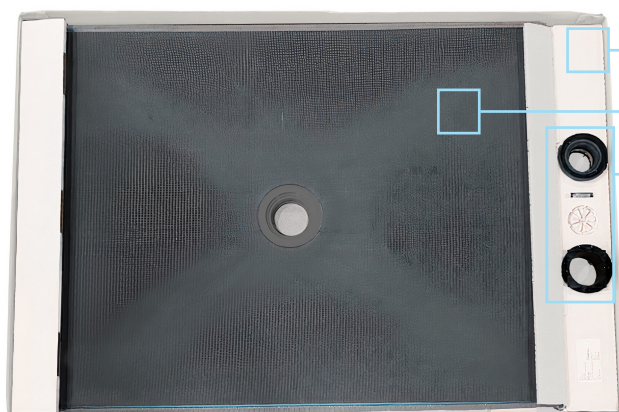

- Shower Base Packaging Inserts
- Fundo Shower Base
- Fundo Click and Seal™ Drain, Lubricant, Strainer Key, Drain Cover Extension

Fundo Click and Seal™ drain and installation accessories shown above come pre-packaged inside all Fundo Shower Base and Fundo Shower Kit boxes.

*Actual photo of shower base packaging

Benefits of Fundo Click and Seal™

- Commercial grade, solid drain body
- Fundo Click and Seal™ Drain fits all Fundo shower bases
- Drain Assembly included with every Fundo shower base or kit
- Drain cover can move both vertically and laterally to accommodate any size tile
- Drain cover can be selected a la carte, but standard cover remains included with Kits
- Drain is equipped with extra weepholes for faster draining of water from thinset mortar layer
- Hair strainer now included in drain assembly
- Fast, clean and simple installation
- No plumbing license, glue or sealant needed
- “Click” sound as check point marks visible from top view into drain confirm the drain has properly sealed to wedi base.
- Seals to ABS, PVC, or cast iron waste pipe- even on drain/floor pipes up to 5° out of plumb
- A special kit is available to seal to copper pipe
- Can be cleanly and safely disassembled and reassembled, if plumbing needs to be replaced



How wedi Supports You - First Time Fundo Click and Seal™ Use

- Find all new Fundo Click and Seal™ product systems, available drain covers, and retail pricing in your new 2023 Technical Handbook. Ask your wedi distributor or dealer for your wedi discount.
- The new pricing for Fundo bases with Click and Seal™ drain is based on consistent square foot pricing, making estimating simple - ask your wedi distributor for your competitive volume discount off wedi retail pricing
- We train you and your crew on site when you install Fundo Click and Seal™ for the first time- schedule on wedicorp.com or give us a call
- Updated workshops and events hosted by Technical Sales Support Managers
- Videos available to support new and old drains used in installation
- www.wedicorp.com transitions to show new Fundo Click and Seal™
- Social media – awareness and training posts to benefit installers and contractors

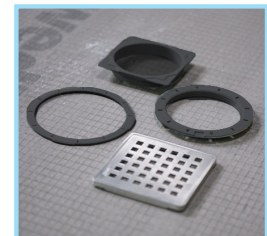

02

Premium Drain Covers

Fundo Click and Seal™ drains fit with all styles of our Fundo shower and can be paired with any of our drain covers (sold separately from shower base which only includes drain unit).

Made in the USA and Germany, our Point and Linear Drainage Premium Drain Covers come in several styles and finishes. The solid makes and shapes are laser cut for extra precision and are individually hand finished and quality controlled for smooth finishes. These high-quality options are sure to provide the perfect addition to your shower oasis.

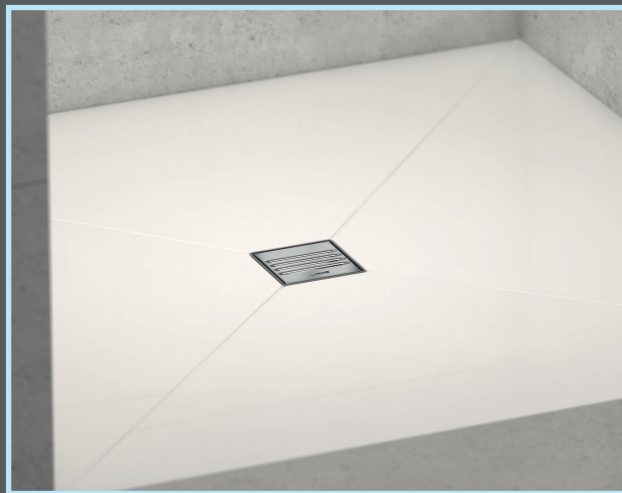

wedi Premium Point and Linear Drain Covers

Premium wedi drain covers are available in several styles and finishes. The point drain Fundo Cover Sets and Fundo Slotted Design Cover sets are 3 3/4 x 3 3/4 inch (nominal 4 x 4 inch as before) and offer sleek, modern finishes for your shower. For a more custom look, go with our 3 3/4 x 3 3/4 inch size and tileable drain cover. Finish options for point drains include: Chrome, Gold, Oil Rubbed Bronze, Matte Black, Slotted, Brushed Stainless Steel and Tileable options.

Additionally, you can select several high-quality linear drain covers made of brushed or polished stainless steel to complete the design aspirations of the wedi Fundo Riolito floor elements. A tileable version is also available. Installation steps can be found within the Fundo Shower Systems manuals.



01 Premium drain cover for Fundo Primo and Ligno: a high grade, polished stainless steel with slotted design.



02 Premium tileable drain cover for Fundo Primo and Ligno: can be tiled with epoxy glue/adhesive or wedi Joint Sealant- used with 1/4 inch (6.4 mm) high tile or stone.



03 Premium tileable drain cover for Fundo Primo and Ligno: can be tiled with epoxy glue/adhesive or wedi Joint Sealant- used with 3/8 inch (9.5 mm) high tile or stone.



04 Standard drain cover for Fundo Primo and Ligno: high grade, brushed stainless steel finish.



05 Premium drain cover for Fundo Primo and Ligno: a high grade stainless steel with matte black finish.



06 Premium drain cover for Fundo Primo and Ligno: a high grade stainless steel with polished chrome finish



07 Premium drain cover for Fundo Primo and Ligno: a high grade stainless steel with polished gold finish



08 Premium drain cover for Fundo Primo and Ligno: a high grade stainless steel with oil rubbed bronze finish.



09 Standard drain cover for Fundo Riolito: a high grade, stainless steel with polished finish.



10 Exclusive drain cover for Fundo Riolito: a high grade stainless steel with double plates and brushed finish.

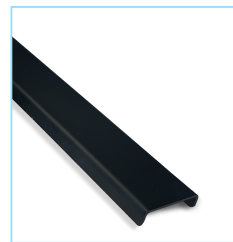

11 Premium drain cover for Fundo Riolito: a high grade stainless steel with matte black finish



12 Channel frame drain cover for Fundo Riolito: a high grade stainless steel channel frame.



13 Exclusive tileable drain cover for Fundo Riolito: can be tiled with epoxy glue/adhesive or wedi Joint Sealant- used with 1/4 inch (6.4 mm) and 1/2 inch (12.7 mm) tile/stone (reverse cover). Drain cover can be adjusted from +3/16 in. to +1 in. from the Riolito base surface (depth for tiling 11 mm).

Fundo Click and Seal™ Installation Tips

Complete installation manuals and videos for installing full wedi Shower Kits and other add ons can be found on our website, www.wedicorp.com. Below, you'll find useful information and imagery pertaining to installing the Fundo Click and Seal™ drain in our Primo, Ligno, Riolito or Riolito Modular shower bases.



The Fundo Click and Seal™ drain component is packaged with each wedi Shower Base. When beginning to install the drain, it is important to note that the drain components are delivered inserted inside the Drain Body inside of the shower base packaging. **Please take the parts out and use each piece step by step following our installation manuals, which you can find on www.wedicorp.com when scanning the QR code on the Fundo box. You can choose from video or written manuals. Drain component parts overview can be found on page 4 of this book.**



wedi provides a safe lubricant packaged with each Fundo Click and Seal™ drain component. Be sure to always use the lubricant on all rubber parts in the assembly. Lubricant packaging may vary.

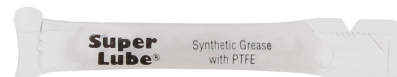

Be sure to **flip your shower base or line module over** before inserting the Fundo Click and Seal™ drain body. The drain body is inserted snugly into the receiving mechanism of the drain unit on the **underside** of the shower base or line module.

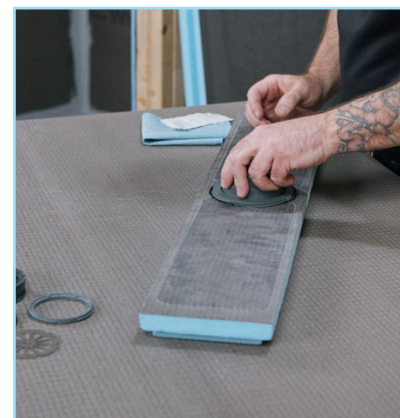

Fundo Click and Seal™ Installation Tips



Once inserted, turn the Drain Body clockwise until its plastic flap clicks in position in its final resting position. This will require no more than a quarter turn. Ensure a tight connection by pushing and pulling on the Drain Body and verifying a flat seat relative to the shower base surface.

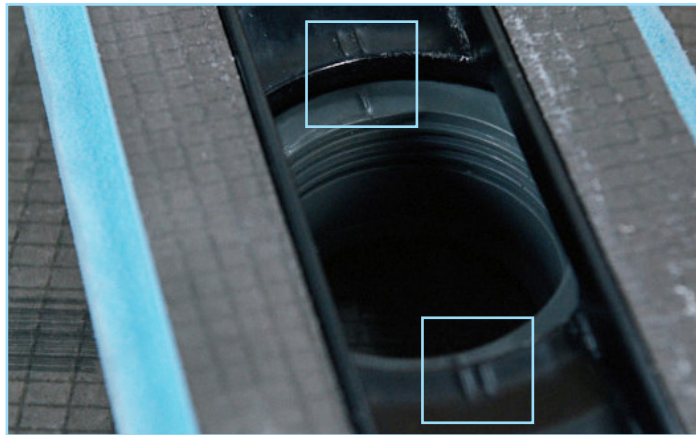
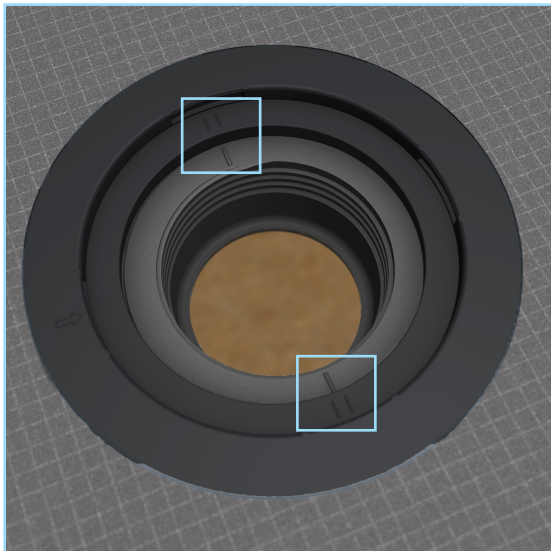

In case it is difficult to hear the click mechanism, on the top side of the base you can also verify the drain unit has successfully connected when the single hash marks are centered between the double hash marks as shown here. Should you want to remove the drain body at any time, this can be done by pushing the snap mechanism's plastic flap inwards using a flat headed screwdriver and unscrewing the Drain Body to the left at the same time.

Next, insert the Sealing Gasket and Compression Spacer **using the provided lubricant**. The compression spacer will push the rubber Sealing Gasket down into its resting position. The Compression Spacer's rubberized part will not always sit flush with the floor waste pipe's edge, which is due to thinset thickness tolerances under the shower base.



For linear drains, use a sharp utility knife to cut the compression spacer into two halves along the pre-made cut lines/notches. This will allow you to insert both halves through the the narrow drain opening. **Note:** The rubberized part of the Compression Spacer is not part of the wedi drain's waterproofing design – it is used solely to keep all dirt out of the drain connections.

Fundo Click and Seal™ Installation Tips

Next, the Locking Nut is inserted with the **notched side up** into the threaded part of the drain unit opening and screwed down until Locking Nut top is flush with the top edge of drain unit's threaded part. Then, the Strainer Key is inserted into the Locking Nut at notch connections and with the Strainer Key **printed side up**. The Strainer Key is used as a tool to tighten the compression seal of the Drain Unit, but remains in place later to serve as a hair catcher to protect the drain and make maintenance and cleaning easy.



Insert a flat headed screwdriver into the Strainer Key slit and turn **LEFT** to tighten the compression seal (turn Counter-Clockwise). Achieve a hand-tight fit and **do not over-tighten**.



Loosely insert Alignment Ring 1, aligning with the arrow printed on the drain unit. Alignment Ring 1 has a threaded inside which will later allow you to insert a Drain Cover Extension. This piece also has built in drainage slits to allow the thinset mortar around the drain area to drain water more quickly.



Insert the Snap Ring 2 into Drain Unit opening with **printed side up**. Align its arrow and protruding key fitting into the notch of the Alignment Ring 1. The Snap Ring 2 needs to be secured in place with its perimeter notches snapping into grooves which are premade in the Drain Unit. Snap Ring 2 is used to secure the movable Alignment Ring 1, and it is needed to later support the Drain Cover unit. It is equipped with drainage slits to allow thinset mortar around the drain area to drain water more quickly.

Next, examine the Drain Cover Extension piece that can be used to increase the position of the drain cover by 1 1/4 of an inch. **The Drain Cover Extension only works for wedi's finished surface drain covers, but not with wedi's tileable covers (item 2 and 3 listed on page 7 of this book) due to their special water drainage design.**

Fundo Click and Seal™ Installation Tips

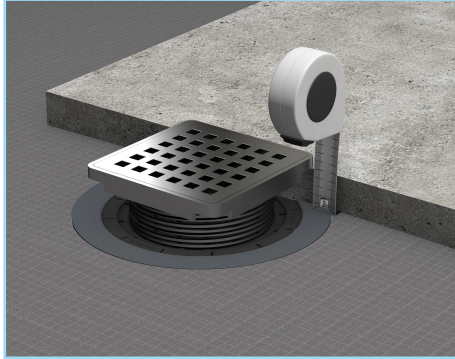

To begin installing the Drain Cover Extension, dry-fit a tile for the shower base right next to the extended drain cover unit and determine to what height the Drain Cover Extension may need to be cut down for a drain cover top flush with the top of the tile (or drain cover top slightly below top of tile). Account for the thickness of the (compressed) thinset mortar used to install the tile. Using a ruler or measuring tape if necessary, match this measurement along the side of the Drain Extension piece.



Make a cut within one of the cutting grooves to adjust the extension to the height needed. Leave the extension a bit longer than needed (by one cutting groove). The Drain Cover Extension should connect to the threaded Alignment Ring 1 securely and for good support, which requires at least one full turn of the extension's male threads reaching into the Alignment Ring 1's female threaded part.











If no height extension is needed, remove all perforated threaded areas, leaving solid threads intact to ensure proper connection to Adjustment Ring 1. **Using the Drain Extension piece is always recommended to ensure a tight drain cover connection when possible.** After connecting the cut Drain Cover Extension piece to the Alignment Ring 1, place the drain cover unit where it fits into a tight seat. The cover is now vertically adjusted and can still be moved $\frac{3}{16}$ of an inch to accommodate the chosen tile, regardless of how much height was added.



Point drain cover units can be moved $\frac{3}{16}$ of an inch in any direction during tiling to allow for a perfect alignment and final positioning and is always fully supported, even after height extension. The cover itself can also be rotated for alignment with tile. The Fundo Click and Seal™ drain installation is now complete!

Drains for Tiled Showers

Key performances in comparison

	wedi Fundo Click and Seal™	Market leading/bonding flange drains
Does not depend on thinset bonded topical waterproofing integration		
Does not involve plastic solvent cement or adhesives		
Weep holes to dry out thinset/tile faster		
Tile supported all the way to drain cover		 *stable flange depends on manually adjusted shims and thinset backfills for support over drain cut out in floor
Hair Catcher included		
Connects to ABS, PVC, and Cast Iron pipe		 *change of methods/plumbing work required
Mechanical adjustment of drain cover height		 *depends on shims, thinset support and manual thinset backfilling action
Mechanical adjustment of drain cover laterally		 *depends on shims, thinset support and manual thinset backfilling action
Works with linear and point drain application		
Visually verifiable seal drain to pipe		
Faster and simpler to install		
Clean installation		



Phone: 1-847-357-9815
Fax: 1-847-357-9819

info@wedincorp.com
www.wedincorp.com



Subject to technical modifications. 11/22.